

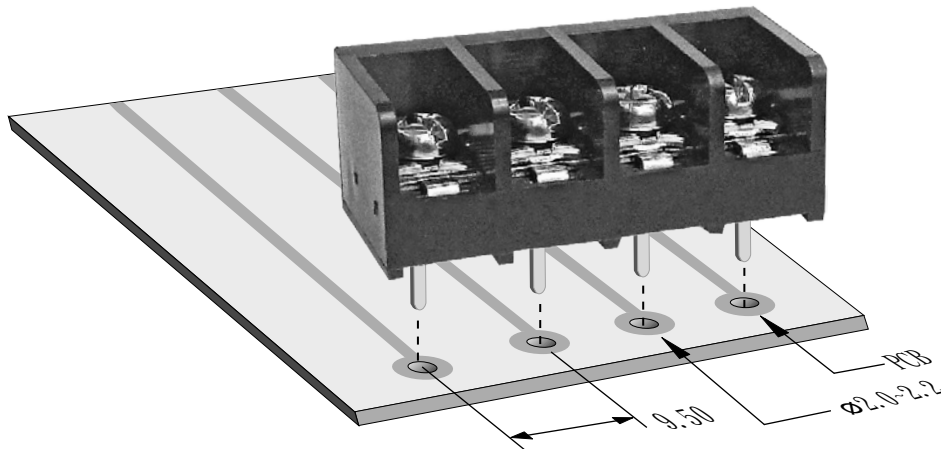









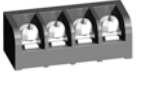

## TYPE:T44 (貫通式端子台)

Pitch:9.50mm

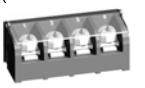

## ORDER GUIDE(注文方法):

# T44 - B S11 - 04

Body(本体)		Terminal style(端子スタイル)				Poles(極数)
<p>A: 取付穴・壁有り、カバー無し (Mount Ends)</p> 	<p>G: 特殊取付穴・壁有り、カバー無し (Barrier Ends with Angle bracketes)</p> 	B1E		S1E		02
<p>B: 取付穴・カバー無し、壁有り (Barrier Ends)</p> 	<p>L: 取付穴有り、金具・壁・カバー無し、金具が付付き (Mount Ends with Standoffs)</p> 	B11		S1N		⋮
<p>E: 取付穴無し、壁有り、カバー付き (Barrier Ends with Cover)</p> 		B21		S11		⋮
		C37		S37		26

## SPECIFICATION(規格,仕様):

Terminal :	Brass, Tin plated,0.8 t	端子金具 :	黄銅板 ハンダメッキ, 0.8 t
Insulator body :	PBT(UL94V-0), Black	本体 :	PBT(UL94V-0), 黒色
Screw :	M3.5, steel, Ni plated	端子ネジ :	M3.5, 鉄ニッケルメッキ
Cover :	PC	カバー :	PC
Operation temperatures :	-40° C to +120° C	使用温度範囲 :	-40° C to +120° C
Rated current :	15Amp 300V	定格 :	15Amp 300V
Insulation withstands volt :	2000V 1min	耐電圧 :	2000V 一分間
Insulation resistance :	2000MΩ at DC 500V	絶縁抵抗 :	DC 500V 2000MΩ
PCB hole Dia :	φ 2.0mm~φ 2.2mm	基板穴径 :	φ 2.0mm~φ 2.2mm
Wire range :	14~22 AWG	適合電線 :	14~22 AWG
Screw torque :	12 lb-in	締付トルク :	12 lb-in
	Screw with washer		ワッシャー付ネジ

# .374" PCB Tri-Barrier Terminal Blocks

**DECA**<sup>®</sup>  
SwitchLab

TYPE:T44

Pitch:9.50mm

## T44-BB1E-04

## Terminal style:B1E

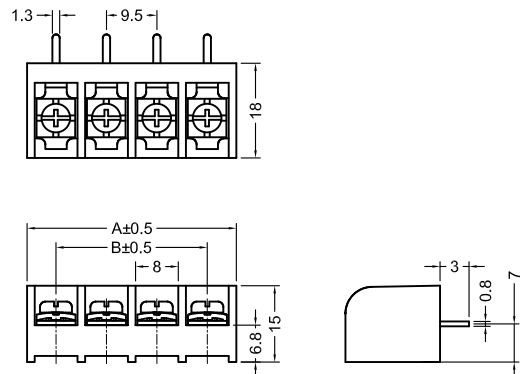
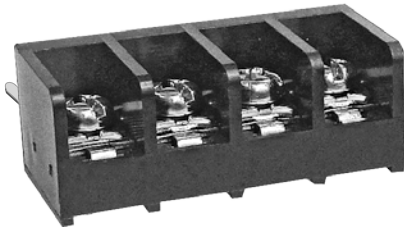

## T44-BB11-04

## Terminal style:B11

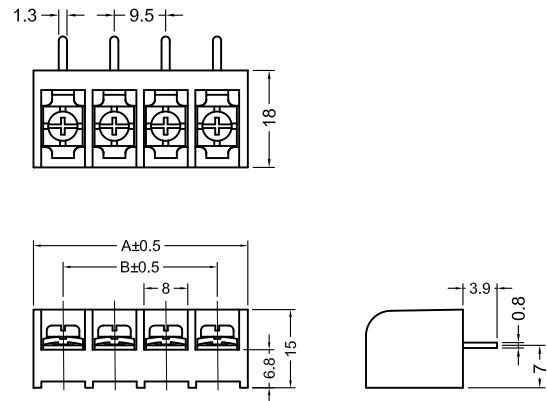
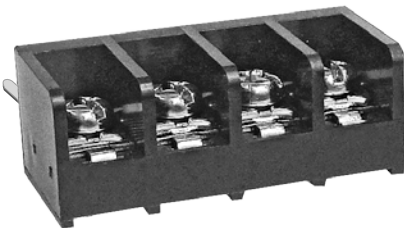

## T44-BB21-04

## Terminal style:B21

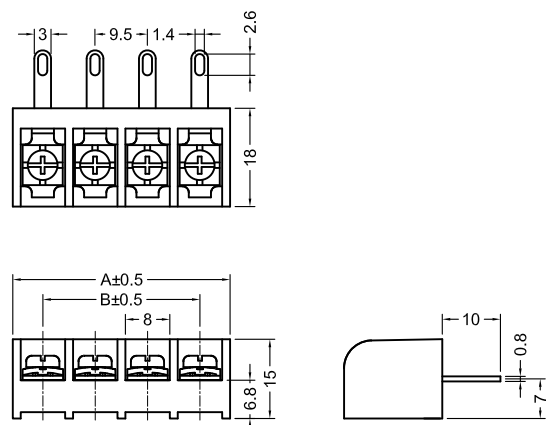
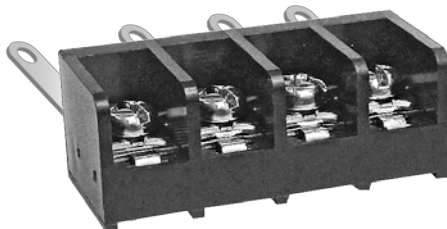

Poles	2	3	4	5	6	7	8	9	10	11	12	13	14	15	16
A(mm)	20.20	29.70	39.20	48.70	58.20	67.70	77.20	86.70	96.20	105.70	115.20	124.70	134.20	143.70	153.20
B(mm)	9.50	19.00	28.50	38.00	47.50	57.00	66.50	76.00	85.50	95.00	104.50	114.00	123.50	133.00	142.50
Poles	17	18	19	20	21	22	23	24	25	26	27	28	29	30	
A(mm)	162.70	172.20	181.70	191.20	200.70	210.20	219.70	229.20	238.70	248.20					
B(mm)	152.00	161.50	171.00	180.50	190.00	199.50	209.00	218.50	228.00	237.50					

# .374" PCB Tri-Barrier Terminal Blocks

TYPE:T44

Pitch:9.50mm

## T44-BC37-04

## Terminal style:C37

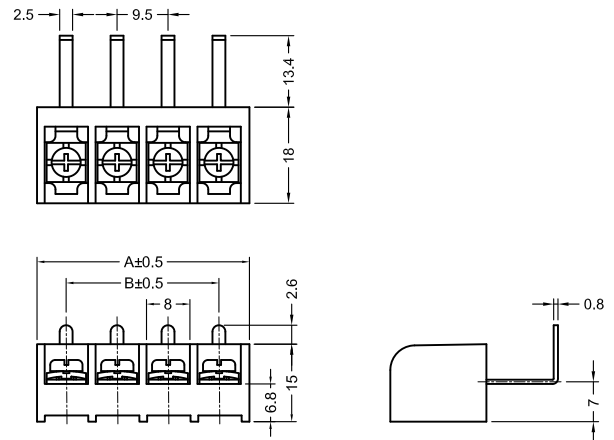
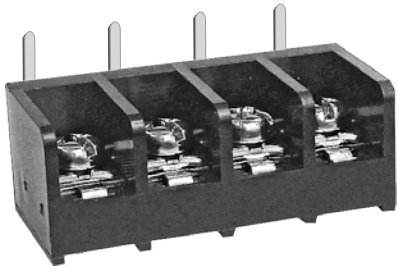

## T44-BS1E-04

## Terminal style:S1E

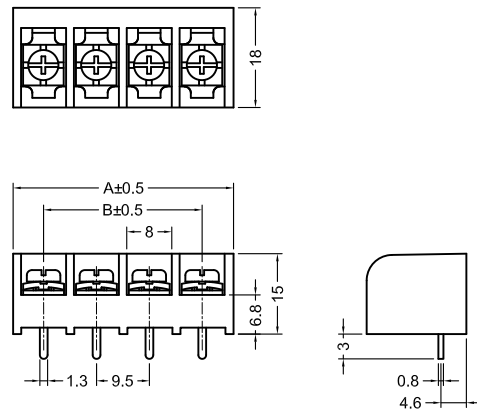
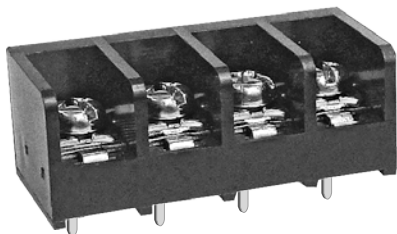

## T44-BS1N-04

## Terminal style:S1N

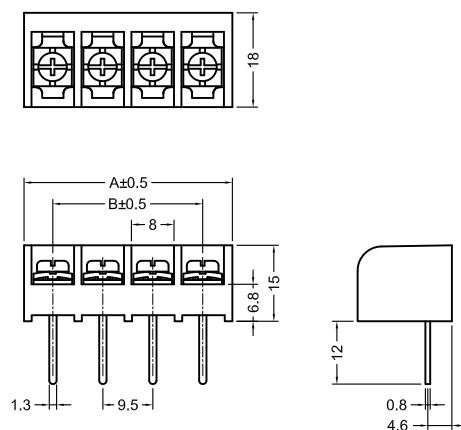
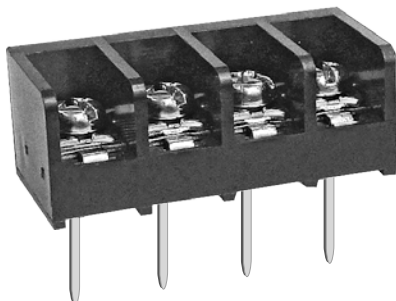

Poles	2	3	4	5	6	7	8	9	10	11	12	13	14	15	16
A(mm)	20.20	29.70	39.20	48.70	58.20	67.70	77.20	86.70	96.20	105.70	115.20	124.70	134.20	143.70	153.20
B(mm)	9.50	19.00	28.50	38.00	47.50	57.00	66.50	76.00	85.50	95.00	104.50	114.00	123.50	133.00	142.50
Poles	17	18	19	20	21	22	23	24	25	26	27	28	29	30	
A(mm)	162.70	172.20	181.70	191.20	200.70	210.20	219.70	229.20	238.70	248.20					
B(mm)	152.00	161.50	171.00	180.50	190.00	199.50	209.00	218.50	228.00	237.50					

# .374" PCB Tri-Barrier Terminal Blocks

**DECA**<sup>®</sup>  
SwitchLab

TYPE:T44

Pitch:9.50mm

## T44-BS11-04

## Terminal style:S11

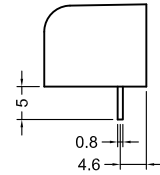
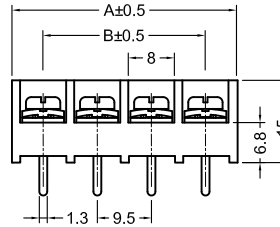
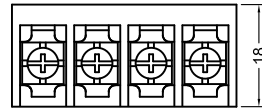
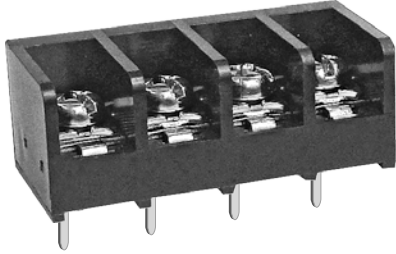

## T44-BS37-04

## Terminal style:S37

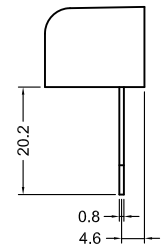
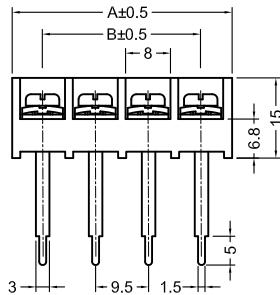
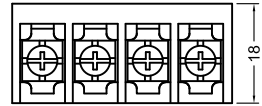
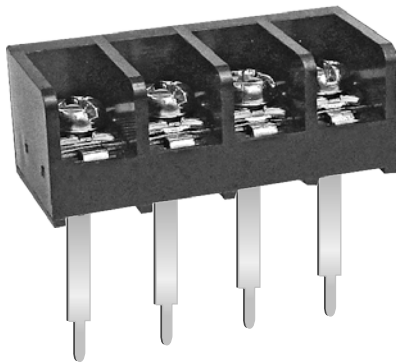

Poles	2	3	4	5	6	7	8	9	10	11	12	13	14	15	16
A(mm)	20.20	29.70	39.20	48.70	58.20	67.70	77.20	86.70	96.20	105.70	115.20	124.70	134.20	143.70	153.20
B(mm)	9.50	19.00	28.50	38.00	47.50	57.00	66.50	76.00	85.50	95.00	104.50	114.00	123.50	133.00	142.50
Poles	17	18	19	20	21	22	23	24	25	26	27	28	29	30	
A(mm)	162.70	172.20	181.70	191.20	200.70	210.20	219.70	229.20	238.70	248.20					
B(mm)	152.00	161.50	171.00	180.50	190.00	199.50	209.00	218.50	228.00	237.50					